

CAST IRON MOTORS (IE1)

Technical Guide



ABOUT US

Established in 1974 as a single bearing shop in Durban, South Africa; BMG's aggressive growth strategy has included acquisitions, supplemented by a steady organic growth discipline. BMG attracts best-of-breed talent resulting in technical expertise that differentiates BMG in the industry. Staff are truly part of the BMG family and its success.

BMG boasts an accredited in-house technical and commercial training academy which fosters a culture of staff development and career advancement; it's all about sustainability.

The net result, is a company that reliably supplies and supports 70 000 customers in 15 countries with the widest range of industrial engineered products and expert services in Africa via 105 branches.

BMG is positioned to deliver bespoke 360 degree solutions to its customers, and subsequently return on investment to its investors and shareholders. BMG plays a pivotal role in supporting the productivity and production targets of all Industrial, Manufacturing, Mining and Agricultural sectors of the economies in the countries it serves. With an enviable reputation as Africa's largest distributor, manufacturer and service provider of the highest quality engineering consumables and components; including

- Bearings & Seals
- Power Transmission Components
- Drives, Motors and Controllers
- Hydraulics, Pneumatics and Filtration
- Heavy and Light Duty Materials Handling
- Valves and Lubrication
- Fasteners, Gaskets and Tools

BMG is a level 4 BEE contributor with ISO 9001 Quality Assurance certification. Health and safety of its employees and customers is a paramount focus and the company adheres to ISO 45001. BMG is also committed to environmental care and sustainability and strictly follows the ISO 14001 charter.

As a key contributor to the Invicta Holdings stable, BMG has played a major part in Invicta's unique achievement of being rated in South Africa's Top 100 Companies for 21 consecutive years.



TABLE OF CONTENTS

INDEX

SABS Certification	1
Cast Iron IE1 Motor	2
Technical Information	3-7
Cast Iron IE1: Performance Data	8-9
Dimensions for the IE1 Cast Iron Induction Motors	10



SABS

Permit to Apply Certification Mark

Subject to the provisions of the Standards Act, 2008
(Act 8 of 2008), the relevant regulations made thereunder and the permit
conditions contained in the under mentioned schedules, this permit authorizes

**SHANDONG HUALI ELECTRIC MOTOR GROUP
CO/BEARING MAN (PTY) LTD - POWER DRIVES
SHANDONG PROVINCE, PR OF CHINA**

Co Reg. 37108272077416X

to apply the certification mark



in respect of the mark specification

**SANS 1804-1:2012 & SANS 1804-2:2012
TO: INDUCTION MOTORS
PART 1: IEC REQUIREMENTS
PART 2: LOW-VOLTAGE THREE-PHASE STANDARD
MOTORS**

- This permit, including the schedules 1 to 3 which form an integral part thereof:
- is issued without alteration;
 - is identified by the applicable permit number;
 - is subject to any condition or limitation contained therein;
 - is valid subject to ongoing compliance with permit conditions;
 - bears the embossed SABS Commercial seal. In the absence of the seal, the permit and the schedules shall be invalid; and
 - the permit may be authenticated by referring to the register of "Certified Clients" on the SABS Commercial website (www.sabs.co.za)
 - Scheme Type 3 permit applies to products that have been tested.

Permit Number 8302/13166

Effective Date 16 April 2019

Expiry Date 23 April 2022

Date of Original Registration 24 April 2007

Chief Executive Officer *Ajabasha*



SABS COMMERCIAL SOC Ltd
1 Dr Lourenço Ndlovu, Greenwood, Pretoria,
Republic of South Africa

AKK4000201

11/2010











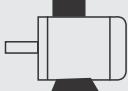

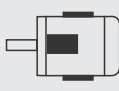
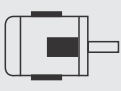
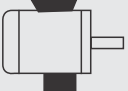

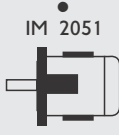
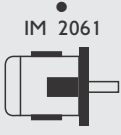

Three Phase Standard Efficiency, Asynchronous Cast Iron Motors

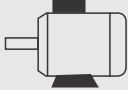
The BMG series three phase asynchronous motor is a custom designed motor, with a Cast Iron housing.

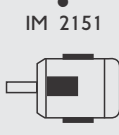
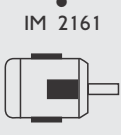
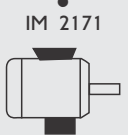
Characteristics for the Standard 3-Phase Aluminium Induction Motors:

- Used in general machinery and industries such as pumps, water treatment, road machinery, petroleum, chemical, metallurgy, cement and paper milling.
- Includes IP55 protection with Class F insulation, Class B temperature rise and S1 duty.
- Rated Voltage: 400V/525V
- Rated Frequency: 50Hz.
- Operating Conditions: Ambient Temperature of -20°C ~ 40°C, Altitude < 1000m.
- A Y-connection for motors of up to 3kW and Δ-connection for 4kW and above.
- The cooling method is IC411.

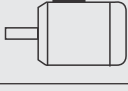
Mounting Arrangements

Types	Basic Type of Construction	Derived Types of Construction				
80-355	IM B3 IM 1001 	IM V5 IM 1011 	IM V6 IM 1031 	IM B6 IM 1051 	IM B7 IM 1061 	IM 88 IM 1071 
80-355	IM B35 IM 2001 	IM V15 IM 2011 	IM V36 IM 2031 	IM 2051 	IM 2061 	IM 2071 
80-160	IM B34 IM 2101 	IM 2111 	IM 2131 	IM 2151 	IM 2161 	IM 2171 
80-355	IM B5 IM 3001 	IM V1 IM 3011 	IM V6 IM 3031 			
80-160	IM B14 IM 3601 	IM V18 IM 3611 	IM V19 IM 3631 			

The basic types of construction may be used in all derived types of construction (*) not-defined, mounting by IEC 60034-7

1) For construction types IM V6, IM B6 & IM 88, an inquiry is necessary.

TECHNICAL INFORMATION

Standard 3-phase motors can be connected using the star or delta method.

A star connection is achieved by wiring W2, U2 and V2 to each other; and U1, V1 and W1 leads to a voltage supply.

A delta connection is achieved by wiring the end of a phase to the head of another.

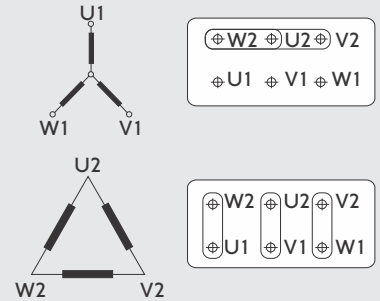

Star-delta (Y/Δ) Starting:

Most low voltage motors are delta wired to operate at 400V and star wired to operate at 690V. This flexibility can also be used to operate the motor under lower voltages. Apart from the fact that the startup current in star-delta starting drops to one third of the direct starting and startup decreases by 25%. The motor is started in star connection and accelerated as much as possible, then it is transferred to a delta connection. This method can only be used in asynchronous motors, which are delta-connected to supply voltage.

Voltage/60hz

Motors are normally designed for 400V, 50Hz. Other voltages and 60Hz frequency are optional. Our motors that are wound for 50Hz, can be operated at 60Hz for the same output power. The ratios given below indicate the changes in the given parameters.

60Hz Application Co-efficients of 50Hz Motors

50Hz Voltage	60Hz Application	Rated Speed	Rated Power	Rated Torque	Rated Current	Starting Torque	Breakdown Torque	Starting Current
220V	220V	1.2	1	0.83	1	0.83	0.83	0.83
220V	255V	1.2	1.15	0.96	1	0.96	0.96	0.96
380V	380V	1.2	1	0.83	1	0.70	0.83	0.83
380V	440V	1.2	1.15	0.96	1	0.95	0.98	0.97

Insulation Classification

The standard motors have class F insulation, while the temperature rise for class B ensures a longer service life.

Class H insulation motors can be manufactured on request.

Under specified measuring conditions in accordance with IEC 60034-1 standard, insulation class F for an electric motor means that at an ambient temperature of 40°C, the temperature rise of its windings reach a maximum of 165K with the additional temperature margin of 10K.

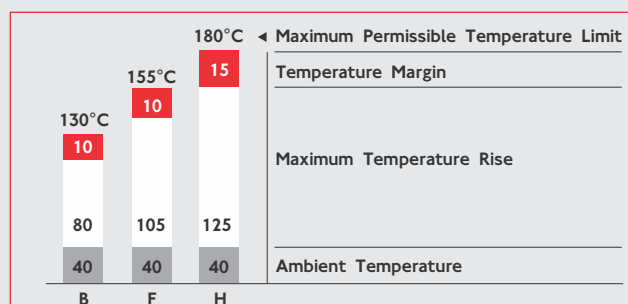

Degree of Protection

According to IEC 60034-5 standard electric motors are provided with an IP code, which determine the degree of protection ensured by the housing against access to dangerous parts introducing foreign matter and/or water.

The First Characteristic Numeral: Protection from Introduction of Solid Foreign Matter

0	Non Protected Machine
1	Machine Protected Against Solid Objects Greater than 50 mm
2	Machine Protected Against Solid Objects Greater than 12 mm
3	Machine Protected Against Solid Objects Greater than 2.5 mm
4	Machine Protected Against Solid Objects Greater than 1 mm
5	Dust Protected Machine
6	Dust-tight Machines

The Second Characteristic Numeral: Protection Against Penetration of Water and It's Harmful Effects

0	Non Protected Machine
1	Machine Protected Against Dripping Water
2	Machine Protected Against Dripping Water Tilted up to 15°
3	Machine Protected Against Spraying Water
4	Machine Protected Against Splashing Water
5	Machine Protected Against Water Jets
6	Machine Protected Against Heavy Seas

Electronic Soft Starters

Through the use of an electronic soft starter, which controls parameters such as current and voltage, the starting sequence can be fully controlled. The starter can be programmed to limit the amount of starting current where, by limiting the rate of the current increase, the startup time can be extended.

VSD Drives

The BMG motor performs optimally, without cogging, at low speeds when operating in conjunction with a VSD. VSD's are primarily recognised for their ability to manipulate power from a constant 3-phase 50/60Hz supply, converting it to variable voltage and variable frequency power. This enables the speed of the motor to be matched to its load, in a flexible and energy efficient manner. Starting torque can only match the full load torque with full load current by using a VSD. The functionally flexible VSD is also commonly used to reduce energy consumption on fans, pumps and compressors. The VSD offers a simple and repeatable method of changing speeds or flow rates.

For operations below 30Hz, the motor cooling fan efficiency drops significantly. In the constant torque applications, a separately driven cooling fan should be fitted to provide sufficient cooling of the motor.

All BMG motors are capable of delivering constant rated power up to 60Hz. However, most of these motors are suitable to run and deliver constant power at much higher frequencies than 60Hz, to a maximum of 100Hz. For applications between 60Hz and 100Hz, please contact BMG for advice on suitability.

The BMG range of motors will operate without modification on VSDs, however under certain conditions, additional features should be considered (see the EDM concerns below). The graph below illustrates the Synergy motor's loadability with a frequency converter.

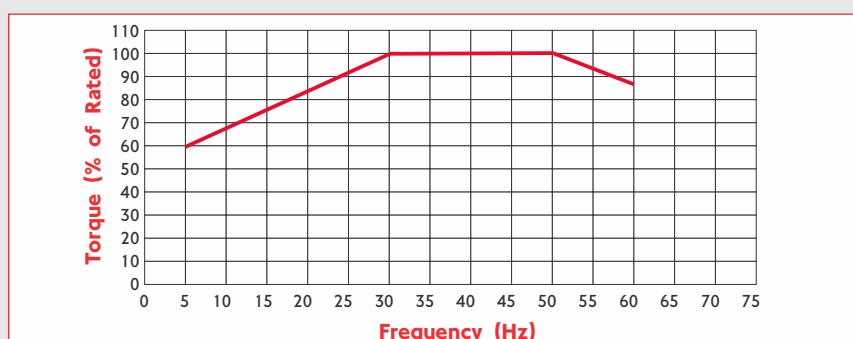

EDM Concerns

Capacitive voltage in the rotor can be generated due to an effect caused by harmonics in the waveform causing voltage discharge to earth through the bearings. This discharge results in etching the bearings' running surface. This effect is known as Electrical Discharge Machining (EDM). It can be controlled by fitting appropriate filters onto the drive.

To further reduce the effect of EDM, an insulated non-drive bearing can be used. BMG recommends the use of insulated bearings for all 315 frame motors and above.

Thermal Protection

Resistance Temperature Detectors (RTDs) and additional thermistors can be installed in both the windings and the bearings.

Thermistors

BMG motors are fitted, as a standard with one set of PTC thermistors (3), selected for a tripping temperature of 145°C. These thermo-variable resistors have a positive temperature coefficient and are fitted per phase in the motor windings.

Additional sets of thermistors (if required for functions such as alarms or to keep as spare) can be fitted with the same or alternate tripping temperatures. Frames 80 to 355 are terminated within the main terminal box.

RTDs

An additional way of monitoring temperature is to install 3 wire PT100 Resistance Temperature Detectors (RTDs).

Torque Characteristics

Typical characteristics of torque behaviour relative to speed are shown in the torque speed curve example below. All Synergy motors exceed the minimum starting torque requirements for design N (normal torque) as specified in IEC 60034-12 and AS1359.41.

Full load torque can be calculated with the formula below:

$$T_N = \frac{9550 \times P_N}{n_N}$$

Where:

- T_N = full load torque (Nm)
- P_N = full load power (kW)
- n_N = full load speed (r/min)
- T_L = locked rotor torque
- T_U = pull-up torque
- T_B = break down torque
- n_s = synchronous speed

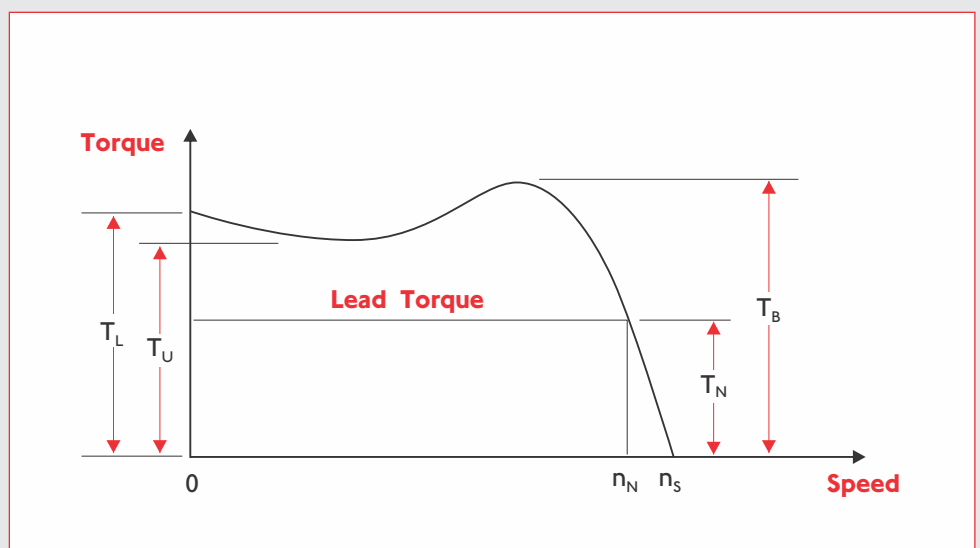

Number of Starts per Hour

The number of start-ups per hour is dependant on the inertia of the driven load and the load torque demand. When a high inertia load is applied (flywheel or heavy fan) please contact your nearest BMG branch for advice. The below table is a guide to generally acceptable start-ups per hour. For a greater number of starts per hour, please contact your nearest BMG branch for advice.

Starts per Hour				
Frame	2 Pole	4 Pole	6 Pole	8 Pole
71*	-	40	-	-
80*	20	40	40	-
90	16	30	40	-
100	16	30	40	40
112	16	30	40	40
132	10	20	25	25
160	10	20	25	25
180	8	15	20	20
200	6	12	12	12
225	5	10	10	10
250	4	8	8	8
280	3	6	6	6
315	3	4	4	4

Permitted Starting Time

The starting time of the motor (from rest to operational speed) should not exceed the recommended time indicated in the table below. The motor must be allowed to cool prior to each start.

Frame	Starting Method	Maximum Starting Time			
		2 Pole	4 Pole	6 Pole	8 Pole
71	D.O.L	-	26	-	-
80	D.O.L	15	26	40	-
90	D.O.L	10	15	25	-
100	D.O.L	12	13	18	40
112	D.O.L	10	10	18	35
132	D.O.L	14	12	12	25
160-355	D.O.L	15	15	20	20
160-355	Star-Delta	45	45	60	60

Lifting Lugs

Motor sizes 90-132, 315 and up are supplied with a lifting lug in Zinc plated Steel.

Terminal Box

The terminal box is located on the top in the D-end in accordance with IEC 60034-7 standards. Terminal boxes can rotate 90°, allowing cable entry from all directions.

Drain Holes

BMG standard motors are designed with drain holes to lead out condensed water. The drain holes are closed with a plastic plug to comply with protection degree IP55. The drain hole can be in the stator housing or in flange/end shield, and always at the lowest point.

TECHNICAL INFORMATION

Bearings

BMG motors are supplied with ball bearings as a standard for all 2 pole motors up to frame size 450. Frame sizes 315 and above are supplied with 4 pole NU bearings as a standard. NU bearings are optional for frame sizes 160 to 280. For special ranges of motors, the bearings can be larger. Angular contact bearings are available on request. All bearing brands available include SKF, NTN or NSK. All motors are fitted with locked bearings in the D-end. Motor size 80 comes with circlips, sizes 90-132 come with a galvanized steel cover and motor sizes 160-355 come with a bearing cover. The bearings are fixed with circlips onto the shaft in motor sizes 160 and above. In front of the ND-end bearing, a spring washer is mounted to make a proper preload of the bearings and minimise the shaft migration. BMG motors are supplied with open bearings and grease nipples for frame sizes 160 and above. Motors from frame sizes 80 to 132 have lifetime lubricated bearings. All standard lubrication nipples are in Brass or Stainless Steel, suitable for all environments.

Bearings				
Frame Size	Driving End		Non Driving End	
	2 Pole	4,6,8 Pole	2 Pole	4,6,8 Pole
80	6205 2Z/C3	6205 2Z/C3	6205 2Z/C3	6205 2Z/C3
90	6206 2Z/C3	6206 2Z/C3	6206 2Z/C3	6206 2Z/C3
100	6206 2Z/C3	6206 2Z/C3	6206 2Z/C3	6206 2Z/C3
112	6207 2Z/C3	6207 2Z/C3	6207 2Z/C3	6207 2Z/C3
132	6208 2Z/C3	6208 2Z/C3	6208 2Z/C3	6208 2Z/C3
160	6209 2Z/C3	6209 2Z/C3	6209 2Z/C3	6209 2Z/C3
180	6211/C3	6311/C3	6211/C3	6211/C3
200	6212/C3	6312/C3	6212/C3	6212/C3
225	6312/C3	6313/C3	6312/C3	6312/C3
250	6313/C3	6314/C3	6313/C3	6313/C3
280	6314/C3	6317/C3	6314/C3	6314/C3
315	6317/C3	NU319	6317C3/7317B(V1)	6319C3/7319B(V1)
355	6319/C3	NU322	6319C3/7319B(V1)	6322/7322B(V1)

NOTE: In case of high radial force, NU bearings are recommended.

Regreasing					
Type	Maximum Relubrication Intervals				Regreasing Quantity (g)
	2 Pole	4 Pole	6 Pole	8 Pole	
WE160-180/B3	3400	7000	9000	10000	30
WE160-180/B35					
WE160-180/B5					
WE160-180/V1	1700	3500	4500	5000	50
WE200-225/B3	2400	6200	8200	9500	
WE200-225/B35					
WE200-225/B5					
WE200-225/V1	1200	3100	4100	4750	
WE250-280/B3	2200	4800	6400	8000	70
WE250-280/B35					
WE250-280/B5					
WE250-280/V1	1100	2400	3200	4000	
WE315-355/B3	1000	3000	5000	6400	100
WE315-355/B35					
WE315-355/V1					

CAST IRON IE1 PERFORMANCE DATA TO SABS 1804 PARTS 1, 2 & 4

2 Pole - 3000rpm: 50Hz

BMG Part Number	Motor Type	Rated Output	Rated Speed	IFL 380V	IFL 400V	IFL 415V	IST IFL	EFF %	Power Factor	Rated Torque	TST TFL	TMAX TFL	M of J kgm ³	Noise Level	Net Weight
0.75KWC2P3B3F	Y3-801-2	0.75	280	1.8	1.7	1.67	5.5	75.5	0.83	2.5	2.3	2.6	0.0008	67	14
1.10KWC2P3B3F	Y3-802-2	1.1	2840	2.6	2.5	2.4	5.6	76.2	0.84	3.7	2.3	2.6	0.0009	67	15
1.50KWC2P3B3F	Y3-90S-2	1.5	2850	304	3.2	3.1	6.1	79.5	0.85	5	2.5	2.9	0.0012	72	20
2.20KWC2P3B3F	Y3-90-L	2.2	250	4.8	4.6	4.4	6.1	81.7	0.85	7.4	0.7	2.9	0.0014	72	24
3.00KWC2P3B3F	Y3-100L-2	3	2880	3.6	6	5.8	6.5	83.1	0.87	10	2.7	2.9	0.0039	76	30
4.00KWC2P3B3F	Y3-112M1-2	4	2880	8.2	7.8	7.6	6.5	84.2	0.88	13.3	2.6	2.9	0.0055	77	38
5.50KWC2P3B3F	Y3-112M2-2	5.5	2880	11.1	10.5	10.2	7.7	85.7	0.88	13.3	2.7	3.2	0.0076	78	43
5.50KWC2P3B3F	Y3-132S1-2	5.5	2900	11.1	10.5	10.2	6.9	85.9	0.88	18.1	2.3	2.6	0.011	80	57
7.50KWC2P3B3F	Y3-132S2-2	7.5	2900	16.9	14.2	13.5	6.9	87.2	0.88	24.5	2.5	2.8	0.013	80	61
11.00KWC2P3B3F	Y3-132M-2	11	2910	21.4	20.4	19.7	6.2	88.4	0.88	36.2	2.2	2.4	0.028	83	73
11.00KWC2P3B3F	Y3-160M1-2	11	2930	21.1	20.1	19.4	6.7	88.7	0.89	35.8	2.6	2.9	0.038	86	101
15.00KWC2P3B3F	Y3-160M2-2	15	2930	28.6	27.2	26.2	6.7	89.5	0.89	48.8	2.6	2.9	0.045	86	111
18.50KWC2P3B3F	Y3-160L-2	18.5	2930	34.6	32.9	31.8	6.8	90.2	0.90	60.4	2.5	2.8	0.055	86	126
22.00KWC2P3B3F	Y3-180M-2	22	2940	41	38.9	37.6	6.6	90.6	0.90	71.4	2	2.8	0.076	89	176
30.00KWC2P3B3F	Y3-200L1-2	30	2950	55.4	52.6	50.7	6.5	91.5	0.90	97.2	2.5	2.7	0.124	92	226
37.00KWC2P3B3F	Y3-200L2-2	37	2950	67.9	64.5	62.2	6.5	92.0	0.90	119.8	2.4	2.6	0.139	92	245
45.00KWC2P3B3F	Y3-225M-2	45	2970	82.1	78	75.3	6.8	82.5	0.90	144.8	2.4	2.6	0.233	92	280
55.00KWC2P3B3F	Y3-250M2-2	55	2970	99.6	94.6	91.3	6.8	93.2	0.90	177	2.5	2.8	0.312	93	379
75.00KWC2P3B3F	Y3-250M2-2	75	2970	134.1	128.4	123.8	6.5	93.7	0.90	241.3	2.3	3.2	0.412	94	466
75.00KWC2P3B3F	Y3-280S-2	75	2970	134.8	128.1	123.5	6.7	93.9	0.90	241.3	2.4	2.7	0.597	94	512
90.00KWC2P3B3F	Y3-280M1-2	90	2970	159.5	151.5	146.1	6.7	94.2	0.91	289.5	2.4	2.7	0.675	94	578
110.00KWC2P3B3F	Y3-280M2-2	110	2970	194.7	185	178.3	6.5	94.3	0.91	353.9	2	2.5	0.86	96	733
110.00KWC2P3B3F	Y3-315S-2	110	2980	194.6	184.9	178.2	6.6	94.4	0.91	352.7	2	2.5	1.18	96	845
132.00KWC2P3B3F	Y3-315M-2	132	2980	233	221.4	213.4	6.6	94.6	0.91	423.2	2.1	2.5	1.55	96	942
160.00KWC2P3B3F	Y3-315L1-2	160	2980	282.1	270	258.4	6.7	94.7	0.91	513	1.9	2.4	1.76	99	1019
200.00KWC2P3B3F	Y3-315L2-2	200	2980	34.7	330.1	318.4	6.7	95.0	0.92	641.2	1.9	2.4	2.02	99	1177
250.00KWC2P3B3F	Y3-355M-2	250	2980	432.3	410.8	395.9	6.5	95.5	0.92	801.5	1.6	2.3	3.56	103	1740
315.00KWC2P3B3F	Y3-355L-2	315	2980	543	515.9	497.3	6.5	95.8	0.92	1010	1.6	2.3	4.1	103	1920

4 Pole

BMG Part Number	Motor Type	Rated Output	Rated Speed	IFL 380V	IFL 400V	IFL 415V	IST IFL	EFF %	Power Factor	Rated Torque	TST TFL	TMAX TFL	M of J kgm ³	Noise Level	Net Weight
0.55KWC4P3B3F	Y3-80M1-4	0.55	1390	1.6	1.5	1.4	5.5	71.4	0.75	3.8	2.2	2.4	0.002	58	13
0.75KWC4P3B3F	Y3-80M2-4	0.75	1390	2.1	2	1.9	5.6	73.5	0.76	5.2	2.2	2.4	0.002	58	14
1.10KWC4P3B3F	Y3-90S-4	1.1	1400	2.9	2.7	2.6	5.4	76.2	0.77	7.5	2.2	2.5	0.002	61	20
1.50KWC4P3B3F	Y3-90L-4	1.5	1400	308	3.5	3.4	5.2	78.7	0.75	10.2	2.4	2.6	0.003	61	23
2.20KWC4P3B3F	Y3-100L1-4	2.2	1420	5.1	4.9	4.7	6.0	81.0	0.81	14.8	2.3	2.6	0.007	64	29
3.00KWC4P3B3F	Y3-100L2-4	3	1420	6.8	6.4	6.2	6.1	82.7	0.82	20.2	2.3	2.7	0.007	64	33
4.00KWC4P3B3F	Y3-112M-4	4	1440	8.8	8.4	8.1	6.5	84.5	0.82	26.5	2.3	2.8	0.01	65	40
5.50KWC4P3B3F	Y3-132S-4	5.5	1440	11.7	11.2	10.8	6.8	85.7	0.83	36.5	2.3	2.9	0.021	71	59
7.50KWC4P3B3F	Y3-132M1-4	7.5	1440	15.6	14.8	14.3	6.5	87.1	0.84	49.8	2.4	3.0	0.03	71	69
11.00KWC4P3B3F	Y3-132M2-4	11	1440	22.6	21.4	20.7	6.8	88.4	0.84	73	2.2	2.7	0.057	75	99
11.00KWC4P3B3F	Y3-160M-4	11	1460	22.5	21.3	20.6	6.9	88.6	0.84	72	2.3	2.9	0.075	75	109
15.00KWC4P3B3F	Y3-160L-4	15	1460	30.3	28.5	27.5	6.8	89.5	0.85	98.2	2.3	2.9	0.092	75	130
18.50KWC4P3B3F	Y3-180M-4	18.5	1470	36.2	34.4	33.2	6.4	90.2	0.86	120.2	2.3	2.9	0.139	76	165
22.00KWC4P3B3F	Y3-180L-4	22	1470	42.9	40.7	39.3	6.9	90.7	0.86	143	2.3	2.9	0.158	76	180
30.00KWC4P3B3F	Y3-200L-4	30	1470	57.5	54.7	52.7	6.8	92.1	0.86	195	2.4	2.9	0.262	79	240
37.00KWC4P3B3F	Y3-225S-4	37	1480	69.7	66.2	64.6	6.5	92.7	0.87	238.9	2.2	2.7	0.406	81	278
45.00KWC4P3B3F	Y3-225M-4	45	1480	84.5	80.3	77.4	6.3	93.0	0.87	290.5	2.3	2.5	0.469	81	308
55.00KWC4P3B3F	Y3-250M1-4	55	1480	103	97.8	94.3	6.4	93.3	0.87	355.1	2.2	2.5	0.66	83	402
75.00KWC4P3B3F	Y3-250M2-4	75	1480	138.4	131.4	126.7	6.2	93.6	0.88	483.9	2.3	2.6	0.88	86	488
75.00KWC4P3B3F	Y3-280S-4	75	1480	138.1	131.1	126.4	6.8	93.8	0.88	483.9	2.1	2.8	1.12	86	540
90.00KWC4P3B3F	Y3-280M1-4	90	1480	165	157	152	6.9	94.1	0.88	580.7	2.2	2.7	1.46	86	615
110.00KWC4P3B3F	Y3-280M2-4	110	1480	201	191	184	6.5	94.5	0.89	709.8	2.1	2.3	2.68	93	717
110.00KWC4P3B3F	Y3315S-4	110	1480	200.5	190.5	183.6	6.5	94.7	0.88	709.8	1.9	2.7	3.11	93	870
132.00KWC4P3B3F	Y3-315M-4	132	1480	240	228	220	6.8	95.0	0.88	851.8	2.3	3.2	3.29	93	990
160.00KWC4P3B3F	Y3-315L1-4	160	1480	287	273	263	6.6	95.2	0.89	1032	2.6	3.0	3.79	97	1053
200.00KWC4P3B3F	Y3-315L2-4	200	1480	359	340	328	6.4	95.4	0.89	1290	2.2	2.8	4.49	97	1243
250.00KWC4P3B3F	Y3-355M-4	250	1490	441	419	405	6.2	95.6	0.90	1603	1.9	2.9	5.67	101	1745
315.00KWC4P3B3F	Y3-355L-4	315	1490	555	527	5.9	6.1	95.8	0.90	2020	2.1	3.1	6.66	101	1957

DIMENSIONS FOR IE1 CAST IRON INDUCTION MOTORS TO IEC SPECIFICATIONS

B3 Mounting

Frame Size	A	AA	AB	AC	AD	AG	B	BB	C	D	DH	E	ED	F	G	GD	H	HA	HD	K	KK	L	LG
80M	125	34	160	175	140	51	100	130	50	19	M6X16	40	25	6	15.5	6	80	10	230	10	M25X1.5	295	106
90S	140	36	180	190	150	60	100	135	56	24	M8X19	50	40	8	20	7	90	12.5	260	10	M25X1.5	320	124
90L	140	36	180	190	150	60	125	160	56	24	M8X19	50	40	8	20	7	90	12.5	260	10	M25X1.5	345	124
100L	160	40	200	215	160	60	140	182	63	28	M10X22	60	45	8	24	7	100	14	275	12	M25X1.5	385	140
112M	190	45	230	236	185	75	140	195	70	28	M10X22	60	45	8	24	7	112	14	310	12	M32X1.5	410	145
132S	216	52	265	275	205	75	140	205	89	38	M12X28	80	63	10	33	8	132	16	350	12	M32X1.5	480	169
132M	216	52	265	275	205	75	178	245	89	38	M12X28	80	63	10	33	8	132	16	360	12	M32X1.5	520	169
160M	254	65	320	330	250	95	210	260	108	42	M16X36	110	90	12	37	8	160	19	425	14.5	M40X1.5	610	270
160L	254	65	320	330	250	95	254	305	108	42	M16X36	110	90	12	37	8	160	19	425	14.5	M40X1.5	655	270
180M	279	74	350	380	270	95	241	297	121	48	M16X36	110	90	14	42.5	9	10	22	460	14.5	M40X1.5	680	277
180L	279	74	350	380	270	95	279	327	121	48	M16X36	110	90	14	42.5	9	180	22	460	14.5	M40X1.5	720	277
200L	315	75	395	420	325	120	305	370	133	55	M20X42	110	90	16	49	10	200	25	515	18.5	M50X1.5	760	300
225S/M 2P	356	75	436	465	335	120	286	355	149	55	M20X42	140	110	18	53	11	225	28	560	18.5	M50X1.5	825	340
225S/M4-8	356	75	435	465	335	120	311	380	149	60	M16X37	140	110	18	53	11	225	28	560	18.5	M50X1.5	850	340
250S/M 2P	406	88	495	520	370	160	349	440	168	60	M20X42	140	110	18	53	11	250	33	620	24	M63X1.5	925	353
250S/M4-8	406	88	495	520	370	160	349	440	168	70	M20X42	140	110	20	62.5	12	250	33	620	24	M63X1.5	935	353
280S/M 2P	457	103	550	570	400	160	368	495	190	65	M16X38	140	110	18	58	11	280	35	685	24	M63X1.5	960	350
280S/M4-8	457	103	550	570	400	160	419	535	190	80	M20X42	170	140	22	71	14	280	35	685	24	M63X1.5	1060	380
315S/M 2P	508	120	630	650	495	195	406	515	216	65	M20X42	140	110	18	58	11	315	45	820	28	M63X1.5	1160	387
*315S/M4-8	508	120	630	650	495	195	457	625	216	90	M16X42	140	110	18	58	11	315	45	820	28	M63X1.5	1270	387
*315S/M 2P	508	120	630	650	495	195	406	515	216	70	M20X42	170	140	22	71	14	315	45	820	28	M63X1.5	1190	417
315S/M4-8	508	120	630	650	495	195	457	625	216	85	M20X42	170	140	22	71	14	315	45	820	28	M63X1.5	1300	417
355M/L 2P	610	125	735	735	640	330	560	775	254	90	M24X50	140	110	20	67.5	12	355	49	1000	28	M63X1.5	1500	420
*355M/L	610	125	735	735	640	330	630	775	254	100	M24X50	210	160	28	90	16	355	49	1000	28	M63X1.5	1570	490

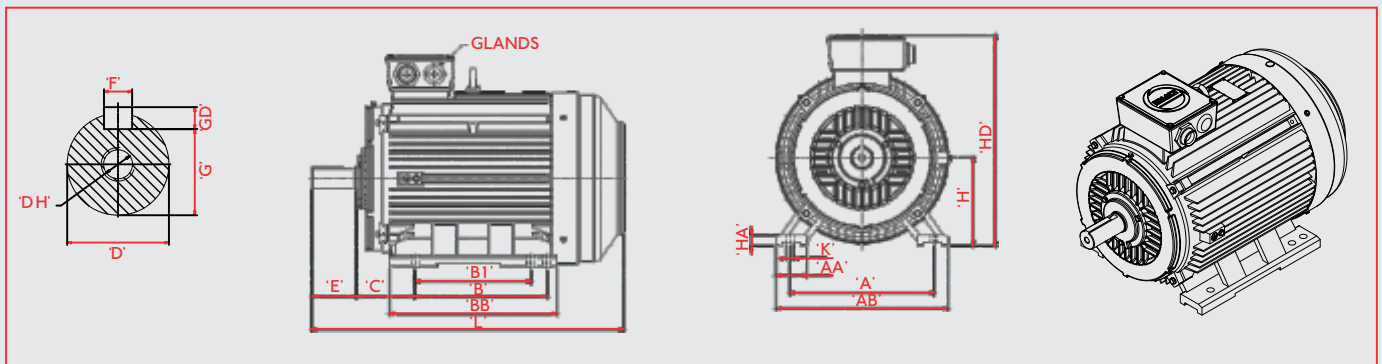

CAST IRON IE1 PERFORMANCE DATA TO SABS 1804 PARTS 1, 2 & 4

6 Pole - 1000rpm:50Hz

BMG Part Number	Motor Type	Rated Output	Rated Speed	IFL 380V	IFL 400V	IFL 415V	IST IFL	EFF %	Power Factor	Rated Torque	TST TFL	TMAX TFL	M of J kgm ³	Noise Level	Net Weight
0.37KWC6P3B3F	Y3-80M1-6	0.37	890	1.3	1.2	1.1	4.4	62.5	0.70	4	1.9	2.3	0.002	54	14
0.55KWC6P5B3F	Y3-80M2-6	0.55	890	1.8	1.7	1.6	4.5	65.0	0.72	5.9	2.1	2.4	0.003	54	16
0.75KWC6P7B3F	Y3-90S-6	0.75	910	2.3	2.2	2.1	4.1	69.1	0.72	7.9	2.3	2.7	0.003	57	20
1.10KWC7P1B3F	Y3-90L-6	1.1	910	4.1	3	2.9	4.6	72.0	0.73	11.5	2.3	2.7	0.004	57	23
1.50KWC7P5B3F	Y3-100L-6	1.5	920	5.6	3.9	3.7	5	76.0	0.75	15.6	2.4	2.8	0.007	61	29
2.20KWC7P2B3F	Y3-112M-6	2.2	940	7.4	5.3	5.1	5.2	79.1	0.76	22.4	2.1	2.5	0.014	65	38
3.00KWC8P3B3F	Y3-132S-6	3	960	9.7	7	6.8	5.6	81.3	0.76	29.9	1.9	2.5	0.029	69	54
4.00KWC8P4B3F	Y3-132M1-6	4	960	12.8	9.2	8.9	6.2	82.3	0.76	39.8	2.1	2.7	0.036	69	62
5.50KWC8P5B3F	Y3-132M2-6	5.5	960	17.1	12.2	11.7	6.5	84.7	0.77	54.7	2.3	2.8	0.045	69	69
7.50KWC8P5B3F	Y3-160M-6	7.5	970	24.5	16.2	15.6	5.6	86.6	0.77	73.9	2.0	2.6	0.088	73	103
11.00KWC8P1B3F	Y3-160L-6	11	970	31.6	23.2	22.4	5.8	87.6	0.78	108.3	2.1	2.4	0.116	73	121
15.00KWC8P1B3F	Y3-180L-6	15	970	39.5	30.1	28.9	5.7	89.0	0.81	147.7	2.0	2.4	0.207	73	173
18.50KWC9P5B3F	Y3-200L1-6	18.5	970	44.7	36.6	35.2	6.7	90.2	0.81	182.2	2.2	2.8	0.315	76	221
22.00KWC9P2B3F	Y3-200L2-6	22	970	59.3	42.5	40.9	6.6	90.2	0.83	216.7	2.3	2.9	0.36	76	236
30.00KWC9P3B3F	Y3-225M-6	30	980	70.1	56.4	54.3	6.8	91.5	0.84	292.5	2.2	2.7	0.547	76	301
37.00KWC9P3B3F	Y3-250M-6	37	980	86	67.4	64.9	6.2	92.2	0.86	360.7	2.0	2.5	0.834	78	370
45.00KWC9P4B3F	Y3-280S-6	45	980	105	82	79	6.1	92.5	0.86	438.7	1.9	2.5	1.39	80	478
55.00KWC9P5B3F	Y3-280M1-6	55	980	140	100	96	6.7	92.9	0.86	536.2	2.1	2.7	1.65	80	535
75.00KWC9P7B3F	Y3-280M2-6	75	985	142	133	128	5.8	93.6	0.86	727.2	2.1	2.3	3.21	85	682
75.00KWC9P7B3F	Y3-315S-6	75	990	170	135	129	6.5	93.7	0.86	723.8	2.0	2.7	4.11	85	790
90.00KWC9P9B3F	Y3-315M-6	90	990	206	161	155	6.2	93.9	0.86	868.6	2.0	2.6	4.28	85	880
110.00KWC9P1B3F	Y3-315L-6	110	990	244	196	188	6	94.5	0.87	1062	1.9	2.7	5.45	85	997
132.00KWC9P1B3F	Y3-315L2-6	132	990	291	232	223	5.8	94.6	0.88	1274	2.0	2.7	6.12	85	1103
160.00KWC9P1B3F	Y3-355M1-6	160	990	362	276	266	6.3	95.1	0.88	1544	1.6	2.8	8.85	92	1400
200.00KWC9P2B3F	Y3-355M2-6	200	990	451	343	331	6.6	95.4	0.88	1930	2.0	2.9	9.55	92	1780
250.00KWC9P2B3F	Y3-355L-6	250	990	451	429	413	6.5	95.7	0.88	2413	1.6	3.0	10.3	92	2050

8 Pole - 750rpm: 50Hz

BMG Part Number	Motor Type	Rated Output	Rated Speed	IFL 380V	IFL 400V	IFL 415V	IST IFL	EFF %	Power Factor	Rated Torque	TST TFL	TMAX TFL	M of J kgm ³	Noise Level	Net Weight
0.18KWC8P3B3 F	Y3-80M1-8	0.18	630	0.88	0.83	0.8	2.9	51.2	0.61	2.8	2	2.2	0.002	52	14
0.25KWC8P3B3 F	Y3-80M2-8	0.25	640	1.15	1.09	1.05	3	54.2	0.61	3.7	2.1	2.4	0.003	52	16
0.37KWC9P3B3 F	Y3-90S-8	0.37	660	1.48	1.41	1.36	3.4	62.2	0.61	5.4	2	2.2	0.004	56	20
0.55KWC9P3B3 F	Y3-90L-8	0.55	660	2.16	2.06	1.98	3.5	63.3	0.61	8	2.1	2.3	0.004	56	23
0.75KWC1P3B3 F	Y3-100L1-8	0.75	690	2.41	2.29	2.21	3.5	70.5	0.67	10.4	2	2.2	0.008	59	31
1.10KWC1P3B3 F	Y3-100L2-8	1.1	690	2.35	3.18	3.06	3.6	72.4	0.69	15.2	2.2	2.4	0.01	59	35
1.50KWC1P3B3 F	Y3-112M-8	1.5	690	4.4	4.2	4	3.9	74.5	0.70	20.8	2.4	2.6	0.017	61	38
2.20KWC1P3B3 F	Y3-132S-8	2.2	710	5.9	5.6	5.4	4.3	79.3	0.71	29.6	2.3	2.5	0.031	64	52
3.00KWC1P3B3 F	Y3-132M-8	3	710	7.8	7.4	7.1	4.4	80.1	0.73	40.4	2.2	2.4	0.01	64	61
4.00KWC1P3B3 F	Y3-160M1-8	4	720	10.2	9.7	9.3	4.4	81.6	0.73	53.1	2.2	2.5	0.075	68	90
5.50KWC1P3B3 F	Y3-160M2-8	5.5	720	13.6	12.9	12.4	5	83.3	0.74	73	2.2	2.4	0.093	68	102
7.50KWC1P3B3 F	Y3-160L-8	7.5	720	17.7	16.8	16.2	5.7	85.9	0.75	99.5	2.1	2.3	0.126	68	122
11.00KWC1P3B3 F	Y3-180L-8	11	730	25.4	24.1	23.2	5.6	87.8	0.75	144	2.3	2.5	0.203	70	150
15.00KWC2P3B3 F	Y3-200L-8	15	730	34	32.3	31.1	5.5	88.3	0.76	196.3	2.1	2.4	0.339	73	212
18.50KWC2P3B3 F	Y3-225S-8	18.5	730	41	39	37.5	5.6	90.2	0.76	242.1	2.2	2.6	0.491	73	285
22.00KWC2P3B3 F	Y3-225M-8	22	740	47.2	44.8	43.2	5.4	90.8	0.78	284	2.1	2.4	0.547	73	385
30.00KWC2P3B3 F	Y3-250M-8	30	740	63.3	60.1	57.9	5.3	81.2	0.79	387.3	2.2	2.5	0.83	73	378
37.00KWC2P3B3 F	Y3-280S-8	37	740	77.5	73.6	71	5.6	91.8	0.79	477.7	2.3	2.7	1.39	75	485
45.00KWC2P3B3 F	Y3-280M-8	45	740	94.1	89.4	86.1	5.2	82.0	0.79	581	2.1	2.8	1.65	76	568
55.00KWC3P3B3 F	Y3-315S-8	55	740	110.8	105.3	101.5	5.7	93.1	0.81	710.1	1.9	2.5	4.79	82	745
75.00KWC3P3B3 F	Y3-315M-8	75	740	150.1	142.6	137.5	5.9	93.7	0.81	968.3	2.1	2.8	5.58	82	805
90.00KWC3P3B3 F	Y3-315L1-8	90	740	177.4	168.5	162.4	6.2	94.0	0.82	1162	2.3	2.9	6.37	82	998
110.00KWC3P3B3 F	Y3-315L2-8	110	740	216.4	205.6	198.1	6	94.2	0.82	1420	2.2	2.8	7.23	82	1175
132.00KWC3P3B3 F	Y3-355M1-8	132	740	259.4	246.4	237.5	6.4	94.3	0.82	1704	1.9	2.7	7.55	90	1580
160.00KWC3P3B3 F	Y3-355M2-8	160	740	313.7	298	287.3	6.3	94.5	0.82	2066	1.7	2.6	11.73	90	1680
200.00KWC3P3B3 F	Y3-355L-8	200	740	386.2	366.9	353.6	6.5	94.8	0.83	2582	1.8	2.9	12.86	90	1995

BRINGING THE WORLD'S BEST BRANDS TO YOU

In the bid to procure cutting-edge components at competitive prices, BMG is able to capitalise on long-standing relationships with leading manufacturers dedicated to excellence in design and production.

Products are imported from around the globe and brought to BMG's strategically located distribution facilities and regional service centres via the main distribution hub in Johannesburg - BMG World. A world-class facility boasting 308 000m³ of fully stocked warehouse space, an accredited training facility and unlimited engineering capabilities.

Preferred Brands:



Our Extensive Coverage Throughout Africa

105
BRANCHES

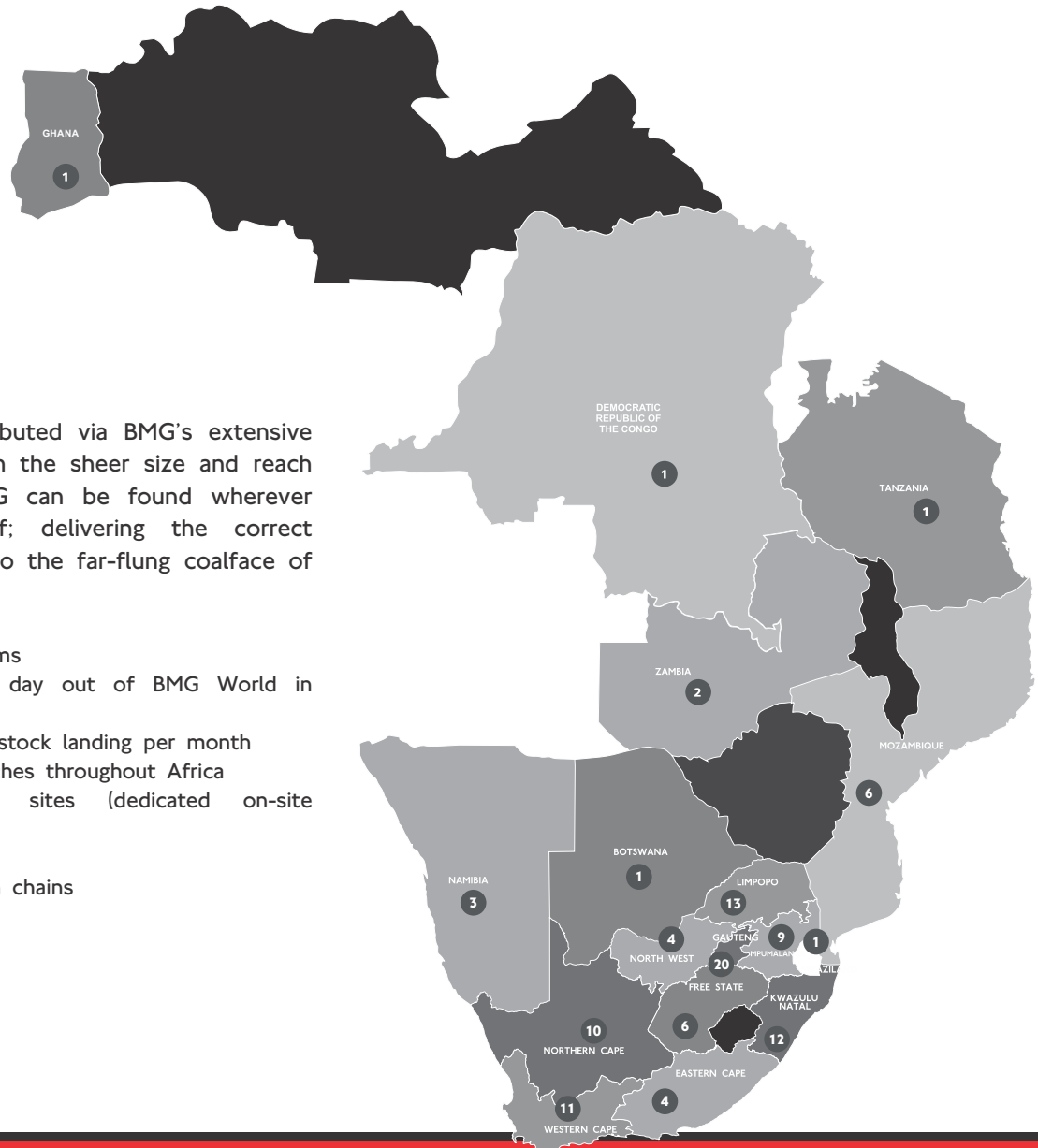

Products and services are distributed via BMG's extensive distribution network. It's through the sheer size and reach of our infrastructure, that BMG can be found wherever industry has established itself; delivering the correct components at the right time, to the far-flung coalface of our customers' operations.

- Over 300 000 product line items
- Around 4 500 transfers per day out of BMG World in Johannesburg
- Over 1 000 tons of imported stock landing per month
- 105 strategically situated branches throughout Africa
- Vendor Managed Inventory sites (dedicated on-site stockholding)
- International exports
- Locally empowered distribution chains

Be PART

24 HR TOLL-FREE EMERGENCY
BRANCH HELPLINE:

0800 022 224

WEBSITE:

www.bmgworld.net



 An Invicta Holdings Group Company

BEARINGS • SEALS • POWER TRANSMISSION • DRIVES & MOTORS
MATERIALS HANDLING • FASTENERS & TOOLS • HYDRAULICS
PNEUMATICS • FILTRATION • LUBRICATION • VALVES
TECHNICAL RESOURCES • FIELD SERVICE

